

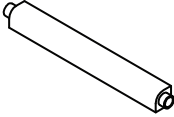







Parts	Description	QTY
	Long Pole	6 Pcs.
	Foot	4 Pcs.
	Cap	4 Pcs.
	Shelf # 1	2 Pcs.
	Shelf # 2	1 Pc.

**PBF-0286 3-Tier Corner Shelf  
Assembly Instructions**

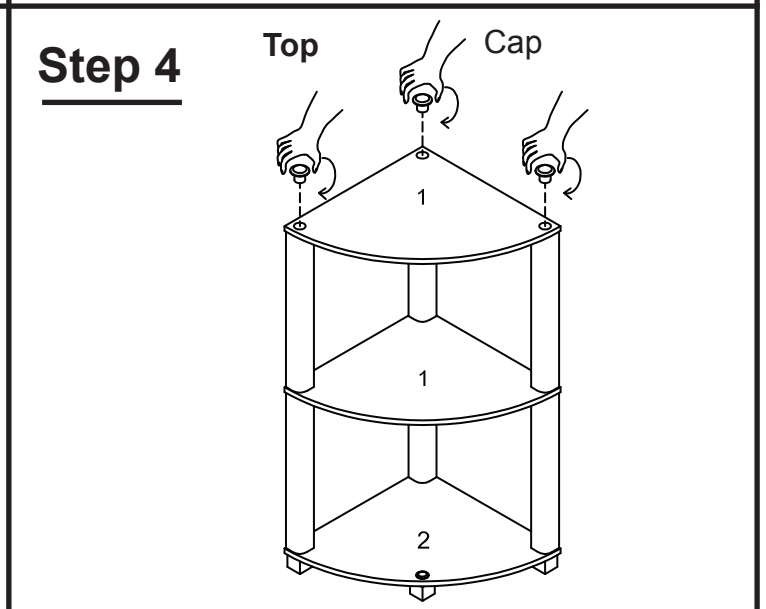
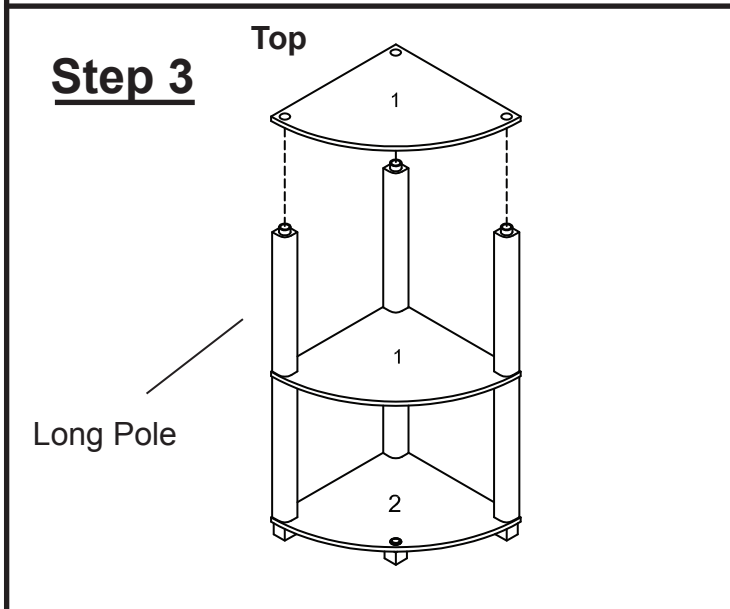
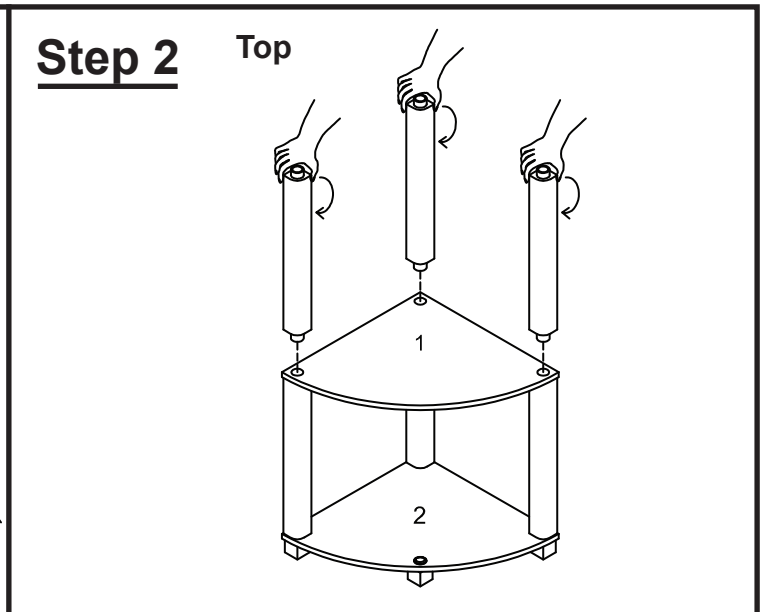
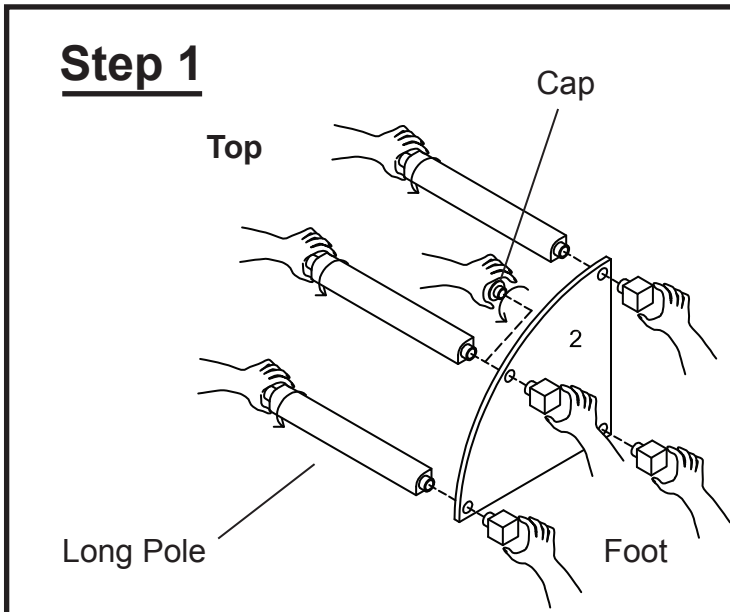
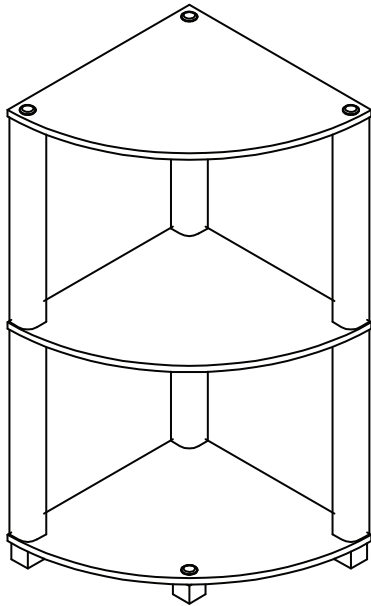
(Care Instructions : wipe with damp cloth)

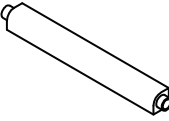



Piezas	Descripción	Cantidad
	Poste Largo	6 Pzs.
	Pie	4 Pzs.
	Casquillo	4 Pzs.
	Estante # 1	2 Pzs.
	Estante # 2	1 Pz.

**Instrucciones de ensamblaje para el librero  
esquinero de tres estantes**

**PBF-0286**

(Instrucciones de limpieza: frotar con un paño húmedo)

<p><b><u>Paso 1</u></b></p>	<p><b><u>Paso 2</u></b></p> <p>Tapa</p>
<p><b><u>Paso 3</u></b></p> <p>Tapa</p>	<p><b><u>Paso 4</u></b></p> <p>Tapa</p> <p>Casquillo</p>