





| Parts | Description | QTY |
|--|-------------|--------|
|  | Long Pole | 8 Pcs. |
|  | Foot | 4 Pcs. |
|  | Cap | 4 Pcs. |
|  | Shelf | 3 Pcs. |

(Care Instructions : wipe with damp cloth)

PBF-0283 3-Tier Book Shelf Assembly Instructions

Step 1

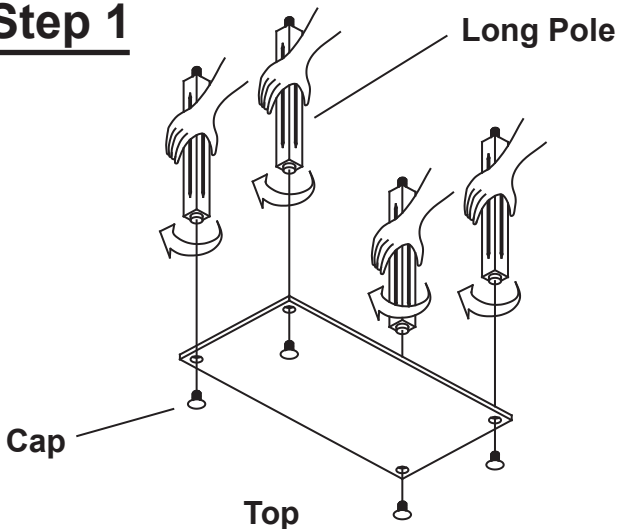



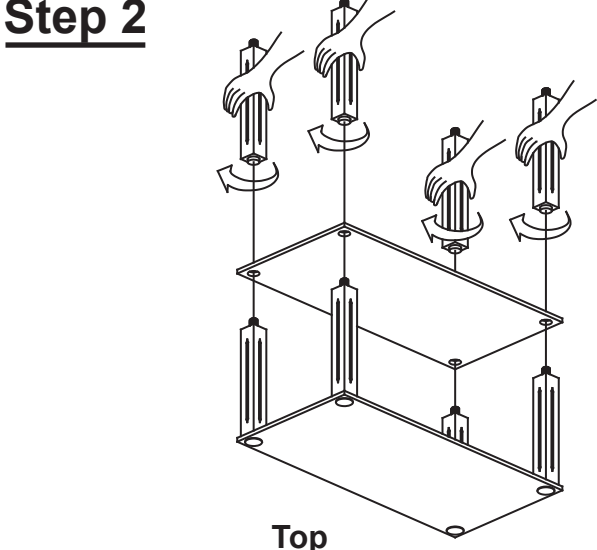

Step 2

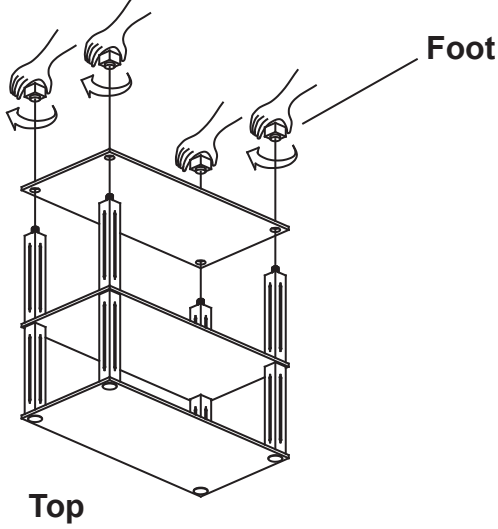

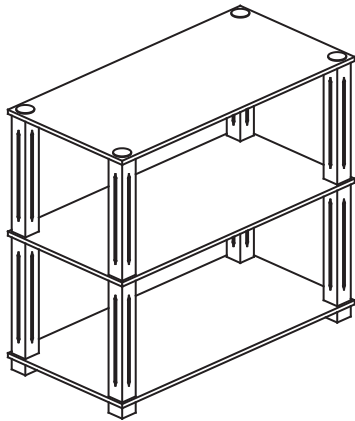
Step 3





| Piezas | Descripción | Cantidad |
|--|-------------|----------|
|  | Porte Largo | 8 Pzs. |
|  | Pie | 4 Pzs. |
|  | Casquillo | 4 Pzs. |
|  | Estante | 3 Pzs. |

(Instrucciones de limpieza: frotar con un paño húmedo)

Instrucciones de ensamblaje para el librero de tres estantes PBF-0283

Paso 1

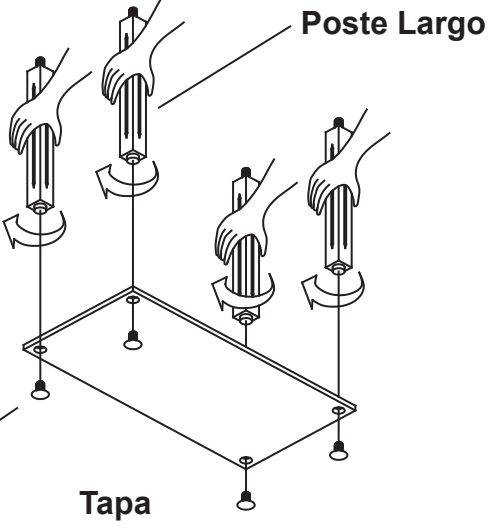

Poste Largo

Casquillo

Tapa

Paso 2

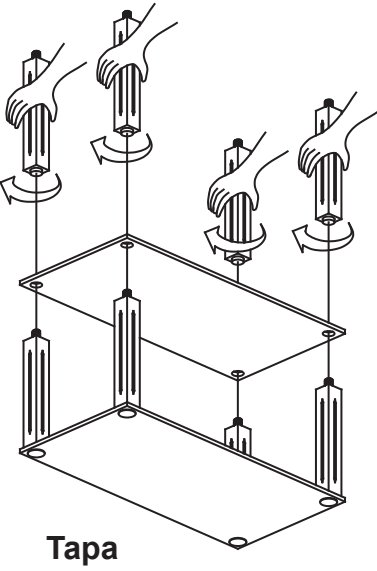

Tapa

Paso 3

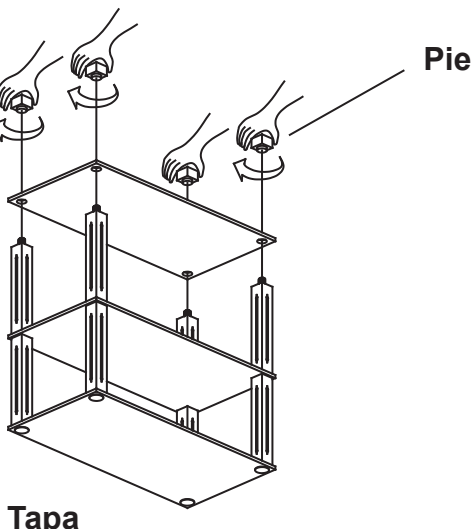

Pie

Tapa