

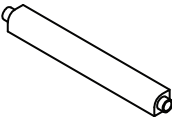

Parts	Description	QTY
	Long Pole	9 Pcs.
	Foot	4 Pcs.
	Cap	4 Pcs.
	Shelf # 1	3 Pcs.
	Shelf # 2	1 Pc.

PBF-0289 4-Tier Corner Shelf Assembly Instructions

(Care Instructions : wipe with damp cloth)

Step 1

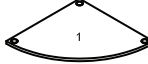
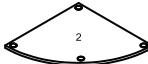
Top

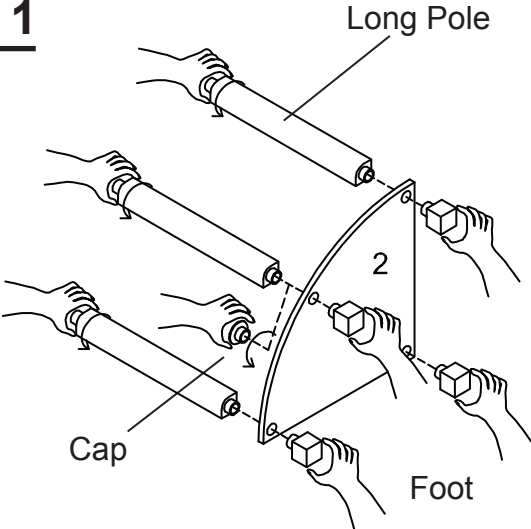

Step 2

Top

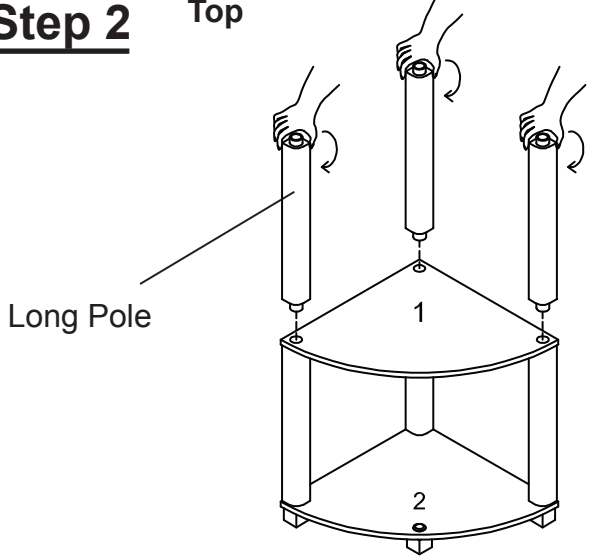

Step 3

Top

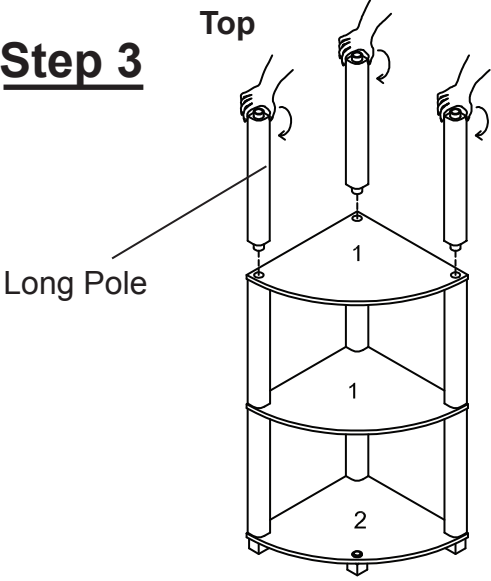

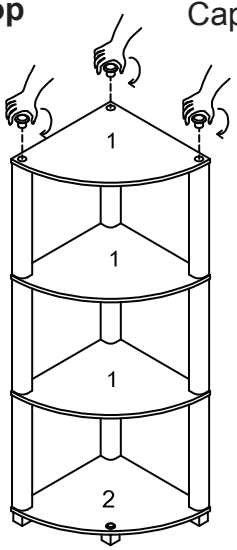

Step 4

Top Cap

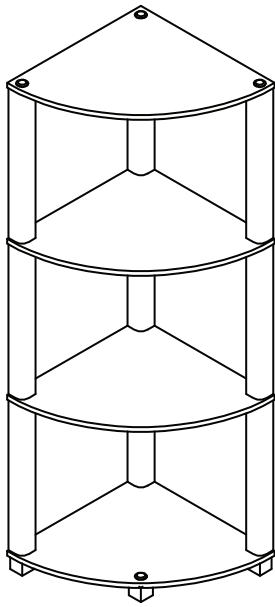

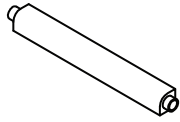

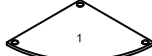
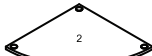
Piezas	Descripción	Cantidad
	Poste Largo	9 Pzs.
	Pie	4 Pzs.
	Casquillo	4 Pzs.
	Estante # 1	3 Pzs.
	Estante # 2	1 Pz.

**Instrucciones de ensamblaje para el librero
esquinero de cuatro estantes PBF-0289**

(Instrucciones de limpieza: frotar con un paño húmedo)

